

- | | |
|---|--|
| <ul style="list-style-type: none"> 10 Film advance and shutter tension crank 11 Shutter release guard 12 Shutter release with cable release socket 13 Locating sockets for panorama head 14 Back lock clip 15 Synchro M-X lever with locking device for flash cord plug 16 Flash cable socket 17 Taking Lens 18 Double bayonet mount for lens accessories and lens hood 19 Shutter speed control 20 Diaphragm control 21 Locking Button 22 Viewing-lens 23 Self-timer release 24 Indicator window for diaphragm and shutter settings 25 Pin-socket for Rolleikin direct view finder mask 26 Direct view finder panel 27 Depth of field scale 28 Focusing scale 29 Focusing knob | <ul style="list-style-type: none"> 30 Adjustable reminder of film type and speed 31 Film-spool knob (Rolleikin rewinding knob) 32 Focal or film plane (focusing distances measured from this line) 33 Exposure table 34 Take-up spool knob 35 Retaining device for Rolleikin ground glass mask 36 Magnifier for eye-level focusing 37 Rear sight for direct view finder 38 Magnifier lifting handle 39 Automatic film feeler mechanism rollers 40 Anti-reflection baffles 41 Winding key of take-up spool 42 Combination back for 120 and 35mm film 43 Adjustable film pressure plate 44 Back locking lever 45 Tripod socket |
|---|--|

The Automatic Rolleiflex is a precision camera of the most advanced modern design. Equipped with lenses of superior optical quality, Schneider Xenar 3.5 or Zeiss Tessar 3.5, it offers superb performance. Even more astonishing to first-time-users is Rolle's extreme handling ease, due entirely to the many exclusive, automatic features incorporated in its design.

The correct methods of holding and handling the camera should be learned from the very start. The following pages contain a fully detailed description, with illustrations, of the construction and functioning of the camera. Helpful rules and hints, fundamental to the practices of Rolle photography, are also included.

We hope that this booklet will help each new Rolleiflex owner to achieve the most complete success with the camera and, of course, in the shortest possible time.

FRANKE & HEIDECKE

BRAUNSCHWEIG

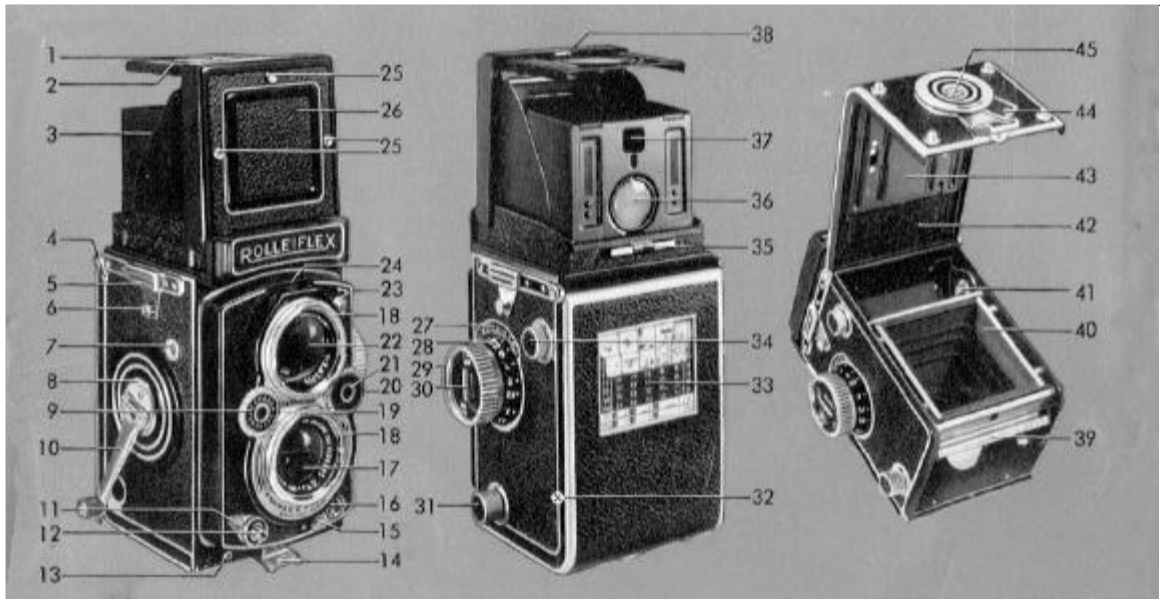

1 Focus magnifier
 2 Magnifier flap
 3 Focusing Hood

4 Locking clip for back hinge
 5 Eyelet slot for neck strap
 6 Neck strap button

7 Film frame counter window
 8 Crank release (to re-tension shutter for double exposure)
 9 Light value scale

2

THE QUICK BASIC PRINCIPLE

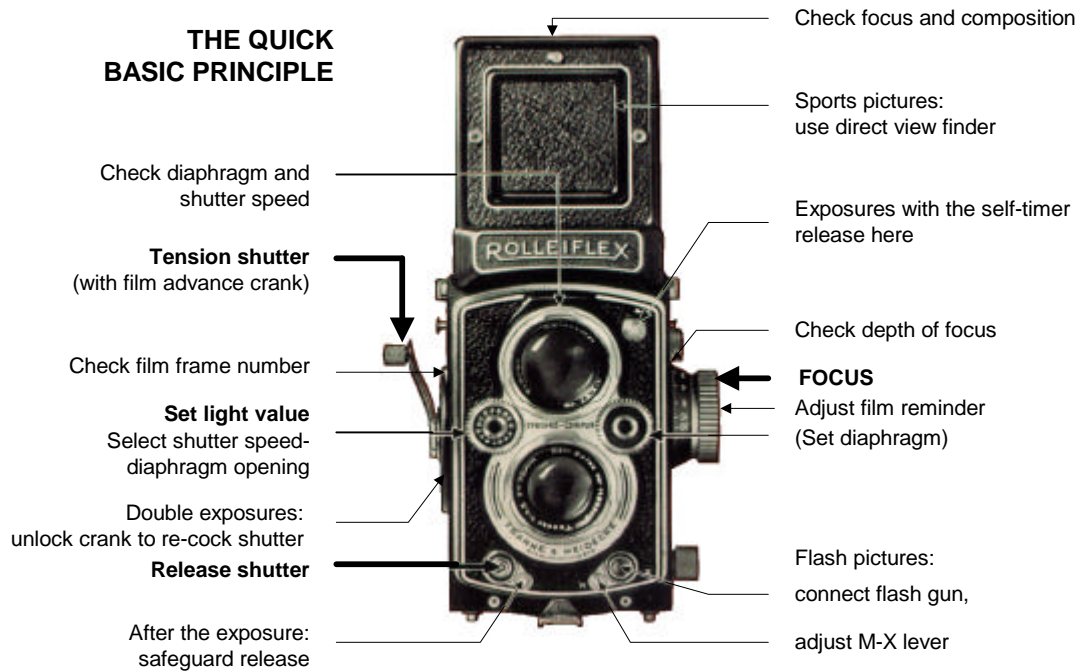

4

TO LOCATE THE MOST IMPORTANT PARAGRAPHS QUICKLY

<p>Page:</p> <p>6 I. A Brief Rolleiflex-Anatomy</p> <p>10 The Automatic Film Transport Mechanism</p> <p>12 II. Rolleiflex in Operation</p> <p>12 Ever Ready Case</p> <p>12 Lens Cap</p> <p>14 Holding the Camera</p> <p>16 Focusing Hood</p> <p>16 Focusing Magnifier</p> <p>17 Direct View Finder</p> <p>18 Focusing</p> <p>18 Diaphragm</p> <p>19 Depth of Field</p> <p>24 Shutter Speed</p> <p>24 Light Value</p> <p>24 Shutter Tensioning</p> <p>25 Releasing</p> <p>26 Self-Timer</p> <p>26 Exposure and Light Value</p> <p>29 Film Reminder</p>	<p>Page:</p> <p>30 III. Loading and Film Transport</p> <p>30 Back</p> <p>32 Inserting Film Spool</p> <p>34 Threading of Film</p> <p>34 Film Transport</p> <p>37 IV. Flashlight Technique</p> <p>40 Flash Photography Tips</p> <p>42 V. Tips on Picture-Taking</p> <p>42 Landscapes</p> <p>44 Portraits</p> <p>45 Children</p> <p>45 Animals</p> <p>46 Snapshots</p> <p>47 Sports</p> <p>48 Theater and Music-Hall</p> <p>48 Night</p> <p>49 Copying</p>	<p>Page:</p> <p>50 Reflecting Surfaces</p> <p>51 Plants</p> <p>51 Color Pictures</p> <p>52 Micro Photography</p> <p>52 Care of Camera</p> <p>52 In Case of Damage to the Camera</p> <p>Tables:</p> <p>21 Depth of Field</p> <p>23 Speed of Moving Objects and Shutter Speed</p> <p>28 Exposure</p> <p>38 Flash-Contact and Shutter Speed</p> <p>53 Practical Accessories</p> <p>54 Rollei Filters</p> <p>55 Rolleinars</p>
---	--	--

Important: Before attempting to use or handle the camera we urge you to carefully read pages 12, 16, 24 and 30.

The image forming rays are transmitted by the fully open viewing lens, projected onto the ground glass screen via the mirror and the result is a right-side-up ground glass image, in the full size of the original picture. This viewing image is visible at all times and every detail of composition and framing may be watched even during exposure.

The ground glass screen is ruled with a number of vertical and horizontal lines making it possible to detect errors, such as lines which converge but should be parallel or a slanting horizon, in time to notice and correct them. It is easy to straighten or level the camera by means of the lines on the ground glass screen.

Above all, the ground glass screen provides the means for **focusing the camera**. This is accomplished by rotating the focusing knob. Both lenses, which are inflexibly coupled to each other by means of a sturdy common front plate, are thereby adjusted simultaneously: a sharp viewing image, therefore, guarantees an equally sharp picture. Since the Rolleiflex is equipped with a fast viewing lens and an optically prepared ground glass screen, the viewing image is extremely bright and clear and focusing can be done very critically.

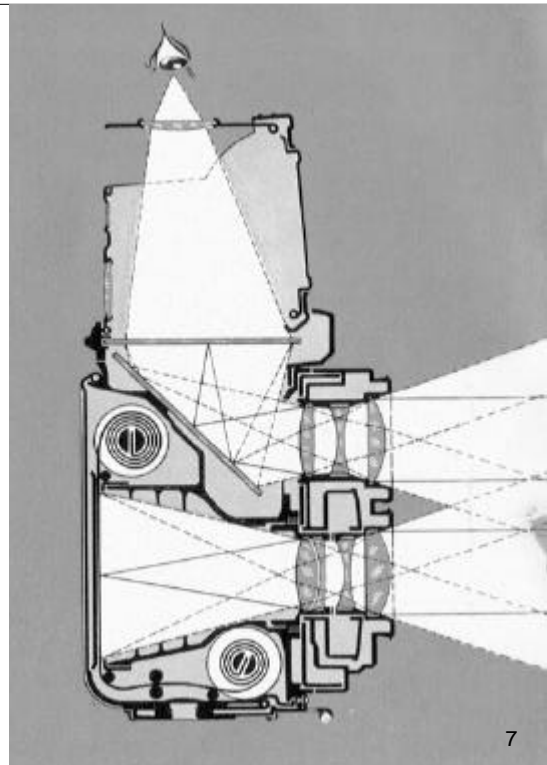

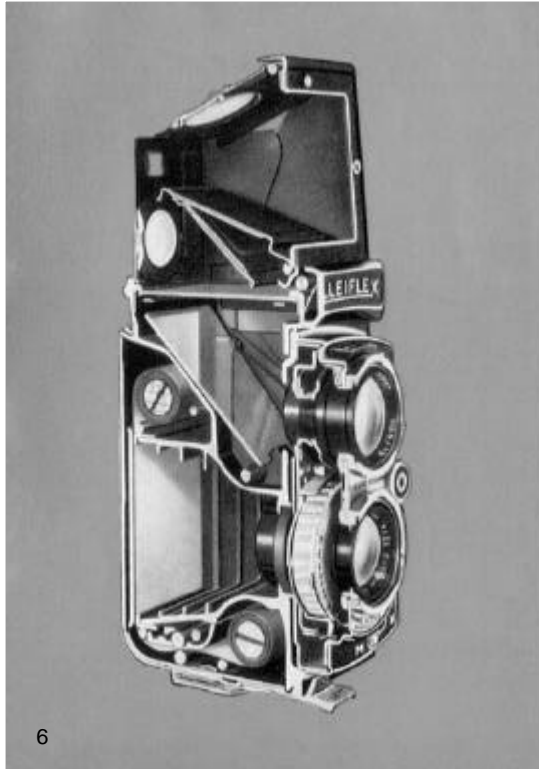

I. A BRIEF ROLLEIFLEX-ANATOMY

The Automatic Rolleiflex is a camera characterized above all by two special design features: the rigid construction of the twin lens reflex and the automatic film transport mechanism. These technical advantages do not form merely a basis for very high performance but at the same time contribute materially to the simplicity and ease of use for which the Rolleiflex is justly famous.

Construction of the Twin Lens Reflex

In the Rolleiflex two separate cameras are joined in a twin-camera with a common sturdy die-cast body: the bottom half is the

taking-camera, in which the film is exposed, and the upper half is the

viewing-camera, which is designed on the mirror-reflex principle. Its special task is to make the focusing visible on the ground glass and to supply a control image essentially similar to that of the prospective picture.

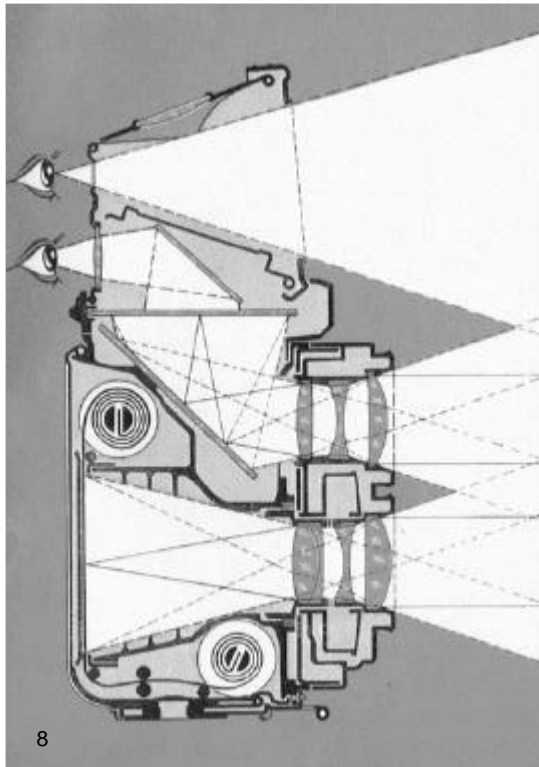

The **focusing hood**, which is designed for one-hand operation, is kept in both open and closed positions by spring tension. It is equipped with a **magnifier** offering approximately 2.5 times magnification for critical focusing.

The rectangular magnifier flap also acts as a shield for the focusing hood and prevents extraneous light from above from reaching the viewing image.

If the front panel of the focusing hood is pushed inward, it is transformed into a **direct view finder** through which the subject may be seen in natural size making it particularly easy to follow fast action. In this case it is still possible at all times to maintain control over focus: this is made possible by means of a second magnifier in the back of the focusing hood, and a diagonally mounted mirror. A slight raising or lowering of the Rolleiflex is all that is required to alternate between the right-side-up open view in the direct finder, and the reversed center portion of the ground glass focusing image. The fact that the two finder openings are located so close together enables quick framing of the subject after focusing. The usefulness of the open direct view finder is thereby enhanced for sports pictures.

Focusing the front lens panel throughout the range from ∞ (infinity) — $35\frac{1}{2}$ inches (distance measured

from the focal or film plane to the subject) is accomplished by one full turn of the focusing knob. The special design of the focusing mechanism (a cam-drive based on the principle of the archimedic spiral) ensures uniform movement of the lens panel in both directions without play or backlash.

Tied in with the movement of the lenses is a simple sliding mechanism, located beneath the ground glass, providing completely automatic **parallax compensation**. Consequently, the final picture is always framed exactly as originally viewed on the ground glass screen. Similarly complete control can be had even when using supplementary Rolleinar lenses for close-up work merely by adding the Rolleipar.

Shutter speeds and **diaphragm openings** are regulated by the small knurled wheels on the front panel while observing the scales in the single peep window at the top. **Light value scale** and **shutter speed-diaphragm coupling** simplifies correct exposure setting and permits quick changes of speed-diaphragm combination.

Since the two **lenses** are of identical focal length ($f=75\text{mm}$, picture angle [across diagonal], 56°) it follows that the images in both sections of the camera will always be critically focused on the same portion of the subject simultaneously.



9

of the roll. Thus the film is always advanced exactly one full frame.

In addition to this, each swing of the crank automatically brings up the next number in the film counter window.

The positioning of the film so that the first frame is correctly placed also is accomplished automatically. After inserting the full film spool in the bottom chamber, the paper leader must be passed through the two feeler rollers and drawn up on to the empty take-up spool. The feeler rollers will allow uninterrupted passage of the thin backing paper. Only when the increased thickness (at the pointer where film joins paper) goes through the rollers, does the automatic tripping mechanism allow the counter to go into action. The crank continues briefly and then stops, firmly — the film has reached the position for exposure No. 1. The pressure of the rollers is released immediately after the passage of the film's beginning so that the rest of the roll will slip through freely.

After the twelfth exposure, the counter mechanism automatically disengages and the crank turns freely, permitting the complete winding up of the fully exposed film.

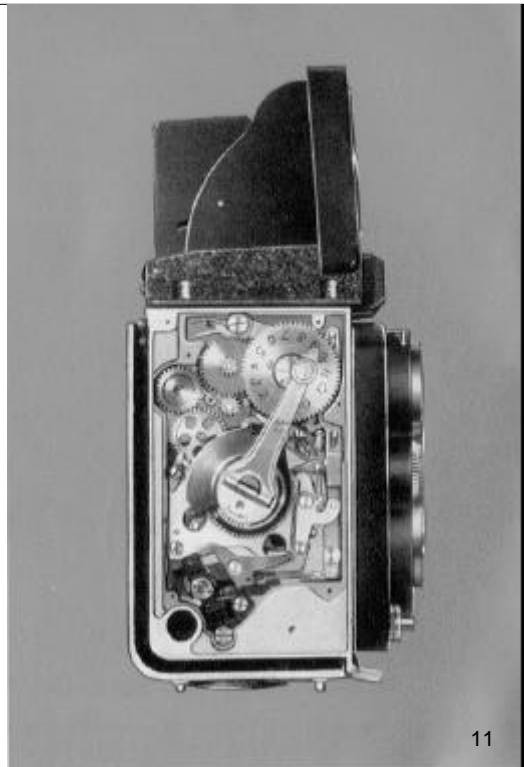

11

The f:3.5 taking lens is a four glass construction with two cemented elements (modified Taylor-type) and features outstanding correction for black and white and color pictures, while the three-element viewing lens f:2.8 meets with the special requirements for best ground glass focusing. Both lenses are treated with abrasion resistance coating. The bayonet receptacles circling the mounts are intended for attaching the lens hood and supplementary optical accessories, which in this way will be held in optically correct position and form a solid unit with the camera.

The removable **combination back** is attached to the camera by means of two hinges with automatic lock and at the bottom it contains the tripod socket and the safety back lock. Its adaptability for the two picture sizes $2\frac{1}{4} \times 2\frac{1}{4}$ ", and 24x36 mm. is the result of the adjustable film pressure plate which can be set for 120 film (with paper backing), or for 35mm film (without paper backing) when used in conjunction with the Rolleikin 2 attachment. In both cases a film channel is created with a width that corresponds to the thickness of the film being used. Thus the film can be properly held in the focal plane, and also can slide through without undue friction when advanced.

10

The Automatic Film Transport Mechanism

The constant readiness of the Rolleiflex, a natural result of its advantageous twin-lens design, is further enhanced by the automatic film transport mechanism. The quick acting **crank** coupled with an automatic gear mechanism performs six important functions with each pendulum swing:

1. Advances film to the next frame
2. Advances film frame counter
3. Tensions the shutter
4. Resets the self-timer mechanism
5. Releases shutter lock
6. Engages film lock

The shutter release and film advance crank are located and unlocked alternately, thereby offering full insurance against double exposures or skipped frames. For intentional doubles exposures the crank must be unlocked at the crank base: Turning the crank a full turn to the left cocks the shutter again without advancing the film.

Automatic stops limit the extent of crank swing. With the increasing thickness of the film on the take-up spool the crank swing decreases from $\frac{3}{4}$ of a turn in the beginning to just under $\frac{1}{2}$ turn at the end

II. THE ROLLEIFLEX IN OPERATION

The Ever Ready Case

deserves mention here since it is so often used with the camera.

The case may also be used with the Rolleikin 2 attachment merely by removing the leather insert to permit passage of the larger counter knob. In order to assure solid contact when working with a tripod (page 31), do not use the ever ready case.

To Open: lift the top by grasping the snap catch buttons at the rear and fold forward and down (1).

To Close: pull the top over the camera and push down to engage the snaps. (Simultaneous folding of the focusing hood is also possible with this movement.) Always return the focusing knob to infinity position since the extended front may otherwise interfere with closing the case.

Removal of Camera from Case: pull up the metal clips located at the top of the sides of the case (2). Lift the crank a little way from the case, spread the case apart, lift the camera forward and out (3).

Putting the Camera into the Case: pull up the clips and spread the case apart; then slip the crank through the large opening from the inside and lower the camera backwards into the case. Push the clips down through the chrome plated strap holder slots.

For Cameras with Rolleikin 2: straighten out the five metal tabs of the leather insert on the inside of the case with a knife (4) and then push out the now superfluous disc.

The Lens Cap

is foldable. The upper part is attached in front of the viewing lens by bayonet mounting and the lower part through friction fit.

To Remove Lens Cap: lift the lower part by the tab at the lower edge and fold it against the upper part (5). Remove cap from bayonet by turning it counter-clockwise $\frac{1}{4}$ of a turn (6).

Attaching Lens Cap: fit the folded cap into the bayonet of the viewing lens — hinge pointing to the right (focusing knob) — and fasten it with a $\frac{1}{4}$ turn clockwise. Fold down the lower part and snap into place.

12

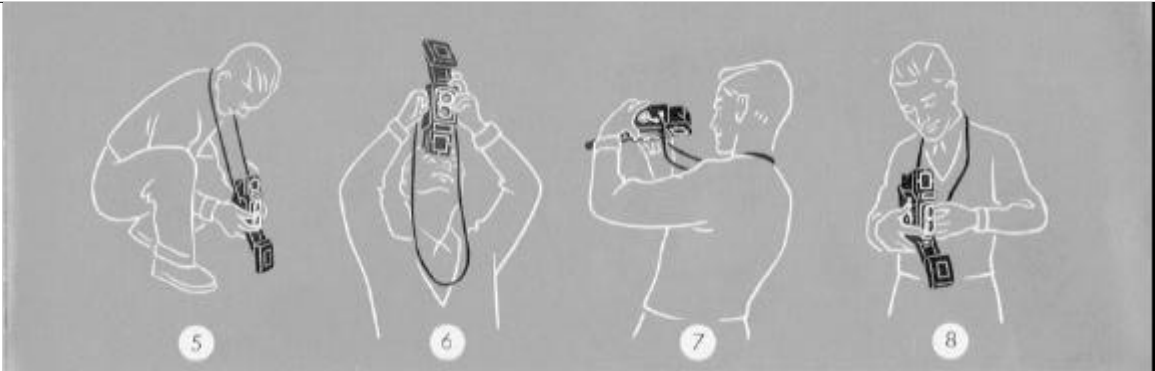
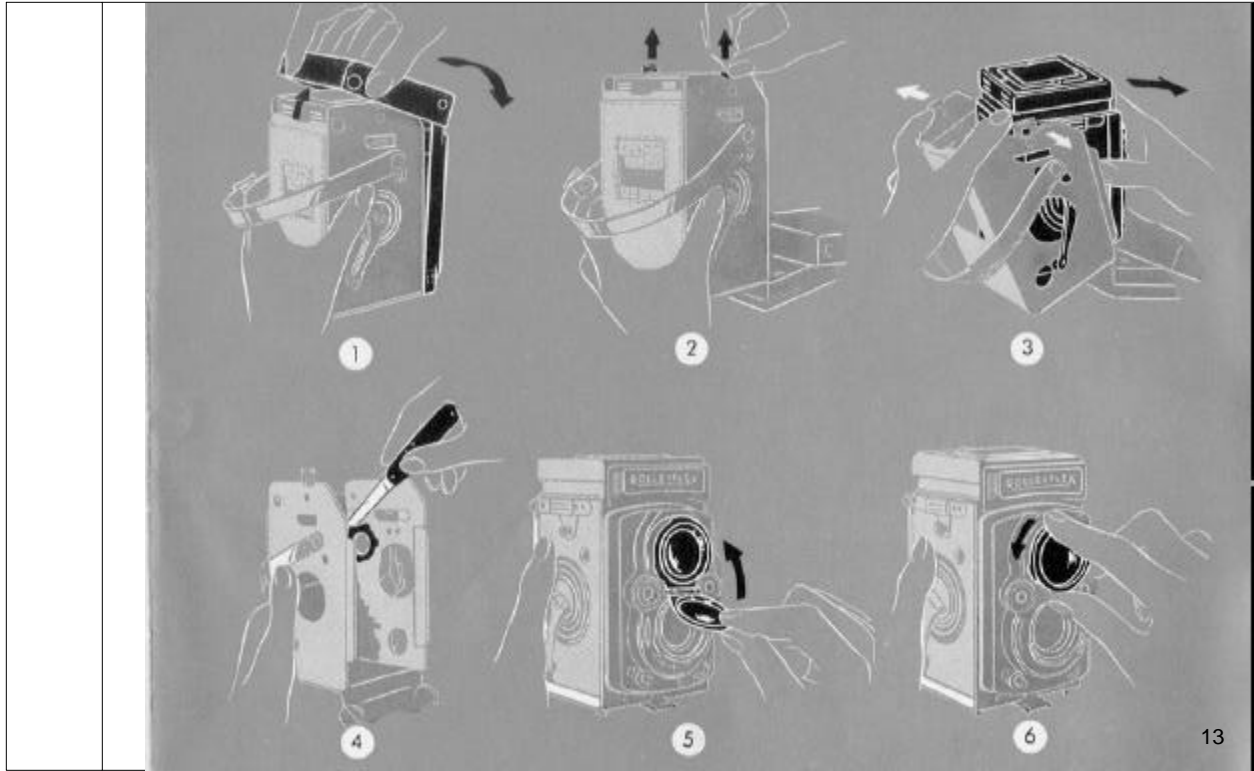

Caution: a wrong or uncomfortable "grip" may cause you to lift inadvertently the hanging top of the ever ready case.

In order to be able to carry the camera slung from the neck without an ever ready case, a special black **leather strap** is available. How to fasten it: hook the metal loop of the leather strap on the strap holder button (4a), pull locking slide up and push it into the strap holder slot as far as it goes (4b).

Waist-level or eye-level positions for the camera are considered normal for most pictures. The extremely flexible Rollei, however, readily permits exposures at or near floor level, overhead, shooting straight up or down, and occasionally, surprise snaps "around the corner" (5)–(8). Thus the viewpoint may be altered at will, in order to obtain a variety of picture effects from different angles.

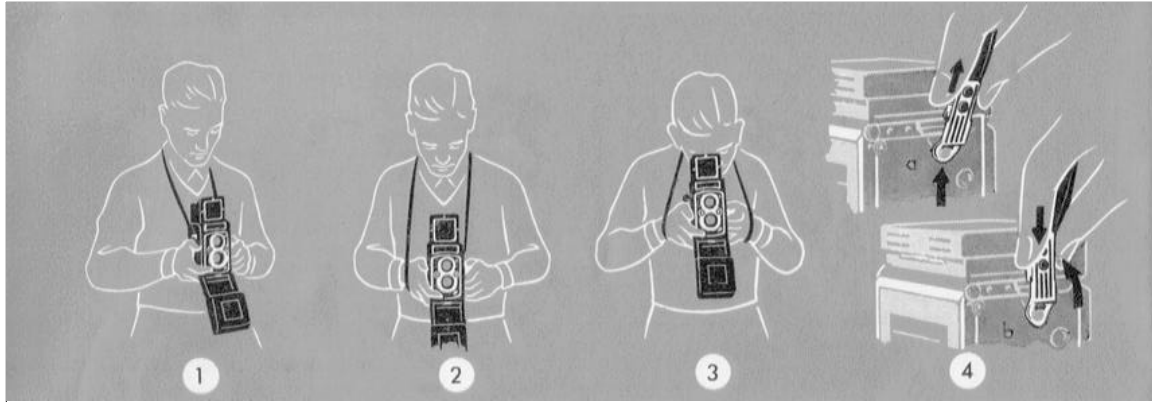

Holding the Camera

Basic rule: camera hanging around the neck with taut strap and held firmly by both hands. The right hand grasps the camera at the bottom, the index finger on the shutter release, the thumb supporting the uplifted crank (quick handling of the film transport: p.36). The left hand does the focusing (1). In this position diaphragm and shutter may be operated comfortably with two fingers.

The Carrying Strap is adjusted to a comfortable length, so that the camera may be carried on the shoulder when not in use. In order that the shutter may be released with taut strap to avoid camera movement, loop the strap around the right hand, thus shortening it to achieve normal viewing distance (2). Further shortening of the strap when using the magnifier can easily be effected by making use of the left hand in the same way (3).



Focusing Hood

To open: lift the rear edge of the focusing hood cover — Spring tension keeps it open (1).

To close: fold down focusing hood (2).

Note: the focusing hood can be closed only with the magnifier in the folded position. The focusing hood may also be closed with the same hand movement that closes the ever ready case (see page 12). The push-button at the rear of the focusing hood serves to hold the Rolleikin ground glass screen mask of the Rolleigrid lens.

Focusing Magnifier

To raise: pull release lever in the open focusing hood upwards — the magnifier springs into position (3).

To lower (before closing focusing hood): push down magnifier flap until it snaps into position. Avoid touching the lens itself (4).

Use of magnifier: use magnifier as close to the eye as possible.

The magnifier is interchangeable and may be replaced for the convenience of near or far sighted people. Strengths from minus three to plus three diopters are available.



Direct View Finder

To open (after raising the magnifier): push the direct view finder flap inwards until it snaps into place (5).

To close: depress magnifier flap slightly — the direct view finder panel immediately returns to normal position (6).

The subject is viewed at eye-level through the direct view finder and focusing may be checked by means of the second (also interchangeable) magnifier.

The two pin-sockets and small knob on the front of the hood permit attachment of the Rolleikin direct

view finder mask.

Changing Magnifier (if eye-sight demands)

To remove: pull back ring mount against retaining spring and lift out. To insert: put into position (back first), pull back against spring and snap down.

Read Magnifier: to remove: push in slightly at top and lift out. To insert: slip magnifier (white dot uppermost) between retaining springs — push down until it snaps into place.

17

Depth of Field

Most pictures subjects require that acceptable sharpness extend somewhat before and behind the exact distance focused on. Landscapes, for instance, require considerable "depth of field". Two factors influence the extent of the sharp zone: distance actually focused on and diaphragm opening.

In contrast to close-up focusing the sharp zone is many times greater when the lens is focused on long distances:

1. The depth of field increases with the taking distance.

In any case, however, the sharp zone of the picture may be increased considerably by stopping down the diaphragm.

2. The depth of field increases when stopped down.

As a practical rule the second alternative is preferable and only in emergency cases should the taking distance be increased because of loss in image size.

The extent of the depth of field at any distance may be read off the focusing knob.

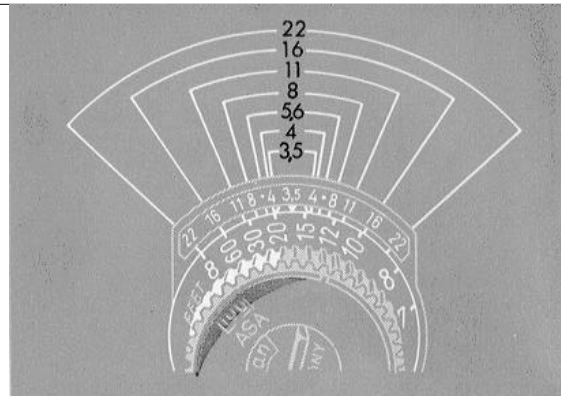

Depth of Field Scale

On and next to the focusing knob two scales are visible: the movable focusing scale with figures indicating feet and the fixed depth of field scale with the diaphragm values. The diaphragm stops 4—22 are arranged in pairs symmetrically on both sides of the central focusing point ▼. The 5.6 positions are indicated by dots.

The center of each footage figure indicates the correct setting for that distance.

19

Focusing

Focus the Rolleiflex by turning the focusing knob, at the same time critically observing the sharpness of the ground glass screen image. The footage scale serves also to indicate the depth of field, a matter which need not concern you too much at first.

The magnifier facilitates the most critical focusing.

Focus so that the greatest degree of sharpness prevails at the main subject distance.

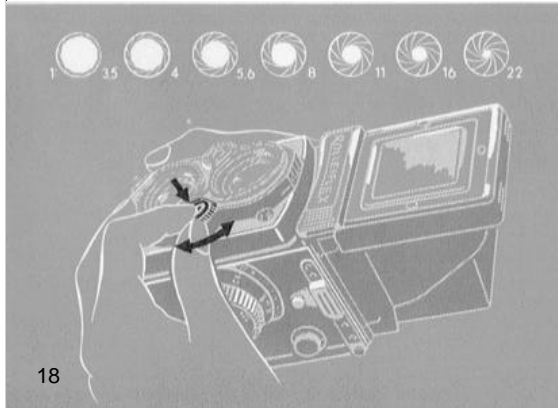

18

The Diaphragm

The diaphragm controls the amount of light passing through the lens. It has a double effect:

Stopping down
i n c r e a s e s the depth of field and
r e d u c e s the effective amount of light

Therefore, the exposure must be increased correspondingly when using a smaller diaphragm opening. This is done automatically in the range between 1/500th — 1 sec. by means of the speed-diaphragm coupling (see page 26). A recalculation is necessary only when using "B", for time exposures. The immediately following table gives correct relative times for use in this case.

Diaphragm	3.5	4	5.6	8	11	16	22
Exposure	$\frac{3}{4}$	1	2	4	6	16	32

Notice that each succeeding smaller stop requires exactly double the exposure of the preceding one (p. 27). Only exception — the relation between f:3.5 and f:4.

The diaphragm scale itself is easily seen, black figures, in the peep window to the left of the lens. The dot before f:3.5 indicates the position for f:4.

Adjusting the Diaphragm: depress locking button and turn control wheel.

In Practice

After focusing, the near and far limits of the depth of field may be read off directly below the pair of figures indicating the diaphragm opening chosen.

Sharp focus extends throughout the area bracketed by the marks representing the selected diaphragm opening

1. Example: focusing to 15 ft with diaphragm opening 11 gives a depth of field from 10 ft to 30 ft approximately, focusing to 10 ft with diaphragm opening f:22 gives on the other hand a depth of field from 8 ft to ∞ approximately. (Stopping down improves the depth of field).

Considerable stopping down necessitates greatly increased exposure time. To obtain depth of field with the largest possible diaphragm opening, a different method of focusing must be employed.

2. Example: the subject requires sharpness from 7 ft to 10 ft. (Other distances, if unknown, can be read directly off the scale after focusing separately to the limits required). Procedure: the focusing knob is turned until both footage values are located opposite identical diaphragm openings, and in this way the most favorable diaphragm opening is obtained, in this case f:8.

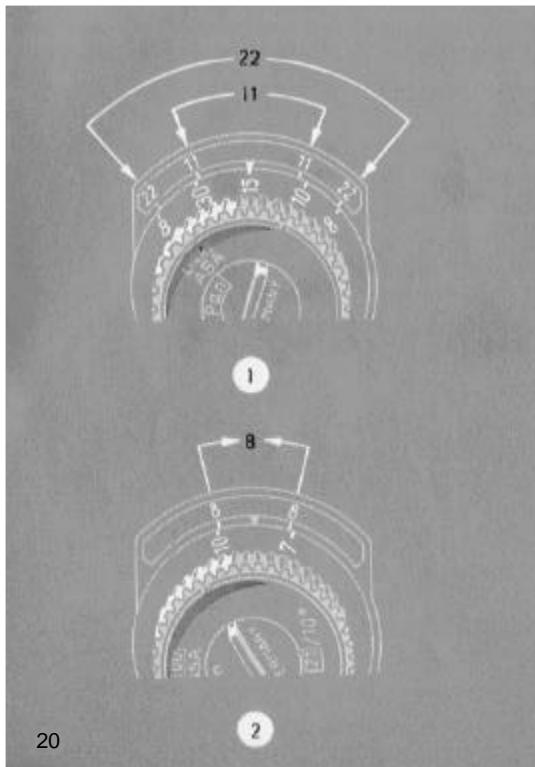

20

Depth of Field Table (distance in feet)

Diaphragm	3.5	4	5.6	8	11	16	22
∞	141' - ∞	86' - ∞	61' - ∞	43' - ∞	31.947' - ∞	21'6" - ∞	15'7" - ∞
60'	42' - 105'	35' - 198'	30'3" - ∞	25' - ∞	20'7" - ∞	15'10" - ∞	12'4" - ∞
30'	24'9" - 38'	22'3" - 46'	20'2" - 59'	17'8" - 99'	15'4" - ∞	12'6" - ∞	10'3" - ∞
20'	17'6" - 23'4"	16'3" - 26'	15'1" - 20'8"	13'8" - 37'	12'2" - 55'	10'4" - 290'	8'9" - ∞
15'	24'9" - 38'	12'9" - 18'2"	12'1" - 19'10"	11'2" - 23'	10' - 29'8"	8'10" - 50'	7'8" - 350'
12'	10'6" - 13'11"	10'6" - 13'11"	10' - 14'8"	9'5" - 16'8"	8'8" - 19'6"	7'8" - 27'1"	6'10" - 52'
10'	9' - 11'5"	9' - 11'5"	8'7" - 12'1"	8'2" - 13'2"	7'7" - 14'10"	6'10" - 19'	6'1" - 27'5"
8'	7'7" - 8'6"	7'5" - 8'10"	7'2" - 9'2"	6'10" - 9'9"	6'6" - 10'7"	6' - 12'5"	5'5" - 15'8"
7'	6'8" - 7'4"	6'6" - 7'7"	6'5" - 7'10"	6'1" - 8'3"	5'9" - 8'10"	5'5" - 10'1"	4'12" - 12'1"
6'	5'9" - 6'3"	5'8" - 6'5"	5'6" - 6'7"	5'4" - 6'11"	5'2" - 7'4"	4'9-1/2" - 8'1"	4'5-1/2" - 9'4"
5'	4'10-1/8" - 5'2"	4'9" - 5'3"	4'7-5/8" - 5'5"	4'6-3/8" - 5'7"	4'4-1/2" - 5'10"	4'1-5/8" - 6'4"	3'10-3/4" - 7'1"
4'	3'10-1/8" - 4'2"	3'10-1/8" - 4'2"	3'9-3/8" - 4'2-7/8"	3'8-1/4" - 4'4-1/4"	3'7-1/4" - 4'6"	3'5-3/8" - 4'9-3/8"	3'3-3/8" - 5'2"
3.5'	3'5-1/8" - 3'6-7/8"	3'4-5/8" - 3'8-1/2"	3'4" - 3'8-1/8"	3'3-1/4" - 3'9-1/8"	3'2-3/8" - 3'10-1/2"	3'1" - 4'0-7/8"	2'11-3/8" - 4'4-1/8"
3'	2'11-3/8" - 3'0-5/8"	2'11" - 3'1"	2'10-1/2" - 3'1-1/2"	2'10" - 3'2-1/4"	2'10" - 3'3-1/8"	2'8-1/4" - 3'4-3/4"	2'7-1/8" - 3'6-7/8"
Diaphragm	3.5	4	5.6	8	11	16	22

Speed of Moving Subjects and Shutter Speeds

	3 mph		6 mph		12 mph		30 mph		60 mph		120 mph					
Example	Pedestrians		Runners Moving air		Bicycles Windy		Light Athletics Stormy Surf		Automobiles Railway Trains Racing		Motor Racing					
Distance (yards)	40	1/30	1/60	1/30	1/60	1/125	1/60	1/125	1/250	1/125	1/250	1/500	1/250	1/500	1/500	50
	15	1/30	1/60	1/125	1/60	1/125	1/250	1/125	1/250	1/500	1/250	1/500	1/500			25
	8	1/60	1/125	1/250	1/125	1/250	1/500	1/250	1/500		1/500					12
	4	1/125	1/250	1/500	1/250	1/500										6

Moving Objects require short shutter speeds in order to be reproduced sharply. For this purpose the table contains computed minimum values, depending on the factors: speed, distance and direction.

Taking distance: the yard column on the left stands for sufficient sharpness (f/4000), the yard column on the right for increased sharpness (f/2000). In spite of these normally

correct figures, it is often possible in actual photography to use longer shutter speeds. This is because the eye interprets slight unsharpness as giving an added impression of speed.

Long arrow = direction of movement.

A short arrow = taking direction (→ up to 10°, ↗ up to 30° and ↑ up to 90° to the direction of movement.

The Depth of Field Table

Since the sharp zone in the picture does not end abruptly, but gradually changes to something less sharp, it is generally sufficient to read the depth of field in round figures. With this in mind the scale on the focusing knob has been calibrated for quick and practical use.

If exact figures are desired, these may be found in the table on page 21.

For normal use the upper of the double row of diaphragm figures is used as in the case when on enlargement is to be made later from the entire $2\frac{1}{4}$ x $2\frac{1}{4}$ negative. (These diaphragm openings are based on a circle of confusion of $1/1400$ of the focal length.)

On the other hand if enlargements are to be made from a small portion of the negative (or Rolleikin negatives), it is advisable to go by the lower row of diaphragm openings (circle of confusion = $f/2000$).

Explanation: the degree of sharpness required from a negative is exclusively dependent on the magnification of the prospective enlargement and its subsequent viewing distance.

22

In order to obtain a correct perspective impression at 10" (a comfortable viewing distance) a whole Rollei negative would have to be enlarged 3.3 x to $7\frac{1}{2}$ x $7\frac{1}{2}$ ". Enlargements of this size, viewed at 10", determine the basis for the minimum acceptable sharpness. With this in mind the size of the circle of confusion is computed and the limits of the depth of field ascertained. Negatives made in this way will permit enlargements also to larger sizes, while still retaining the same impression of sharpness. This is because the viewing distance is always correspondingly increased.

With enlargements from portions of Rollei negatives or from Rolleikin negatives, the requirements with regard to sharpness are more critical. In this case depth of field is calculated using a smaller circle of confusion. In practical use the required depth is obtained through the use of a smaller diaphragm opening. The effectiveness of the scale on the camera itself may be extended in the same manner merely by using the next smaller diaphragm opening than the one indicated for the desired zone.

If enlargements of very great size are to be made, use a diaphragm opening two stops small than the one indicated.

Hand-Held Pictures: Fast Speeds					Tripod Pictures:					
					Slow Speeds				Time Exposure	
1/500	1/250	1/125	1/60	1/30	1/15	1/8	1/4	1/2	1	B

The Shutter Speed

The Synchro-Compur shutter is a between the lens shutter operating at the above designated speeds. In-between speeds are not possible. 1/60th second represents the most commonly used instantaneous shutter speed which minimizes risk of camera movement. Shutter speeds longer than 1/30th second are generally safe only with a tripod. To avoid unsharpness due to subject movement, see table page 23. Shutter speed values appear in the peep window as red figures — read them as denominators of the fraction values, i.e., 30=1/30 second. Selected scale values will resist accidental displacement through click stops.

Setting the shutter speeds: depress locking button on the diaphragm wheel and turn shutter speed wheel (1a).

The Light Value is set on the appropriate scale, located on the shutter speed control wheel. See page 26 for information on the use of light values.

24

Setting the Light Value: depress locking button on the diaphragm wheel and turn shutter speed wheel (1a) or diaphragm wheel (1b).

Shutter speed-diaphragm opening change: while retaining same light value: turn shutter speed wheel only (1a).

Shutter tensioning

Tensioning together with film advance is automatic through crank action (page 34). Tensioning without film advance — possible only with roll-film loaded camera — for intentional double or multiple exposures: Move release ring at base of crank in direction of arrow and then turn crank through one complete backward revolution until it stops (2).

Tensioning with Rolleikin: automatic through crank action. Double exposures not possible.

Tensioning with Plate Adapter: swing crank normally, through 180°, and back to stop. Repeated tensioning for multiple exposures possible.

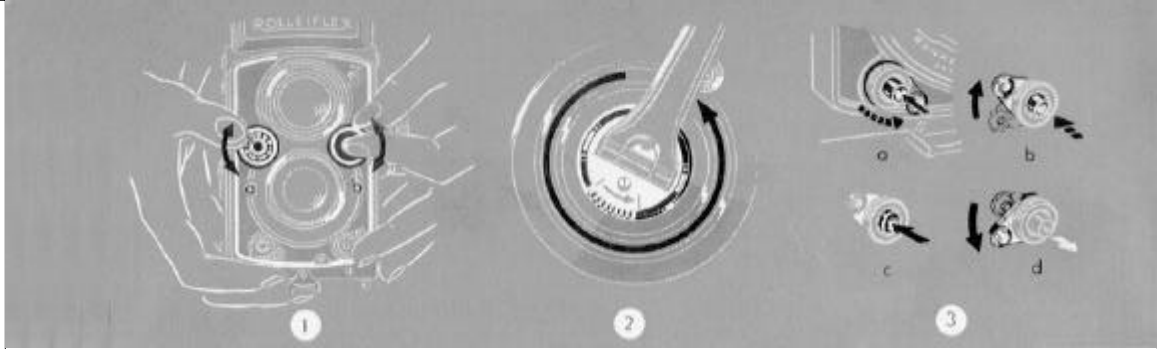

Releasing Shutter

The body shutter release is locked when the safety guard is in the upper position and unlocked when it is swung down (180°) to the lower position. When the release button is pressed, a slight but distinct resistance is felt and then the shutter is immediately actuated. — The depressed release button may also be locked in this position for long time exposures.—

A cable release may be screwed into the release button and can be operated whether the button is locked or not.

Instantaneous exposures: with release guard in lowered position, press release button gently until it stops (3a).

Time exposures: set shutter to "B", unlock release button, press and hold for duration of exposure. To reduce possibility of camera movement, use a cable release.

Long Time exposures: set shutter to "B", depress release slightly (not enough to open shutter) and swing guard to lock it into this position (3b). Exposure: press release completely (3c) and terminate by swinging release guard downward (3d).

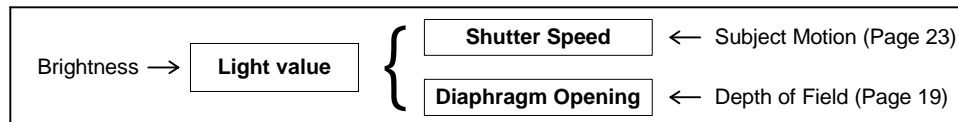

If the "B" setting appears when choosing the shutter speed diaphragm combination it will indicate that double the next previous setting is required, or 2 seconds. Exposure time is doubled for each smaller diaphragm opening. For example, light value 6:

Shutter Speeds	1/4	1/2	1	(2)	(4)	(8)
Diaphragm Opening	4	5.6	8	11	16	22

Intermediate values may be used on the light value scale. In such cases between figure diaphragm positions will result, although automatic coupling in the proper relationship will still be maintained. f:3.5 is itself an example of an intermediate stop, positioned between f:2.8 and f:4 of the international diaphragm scale.

The **exposure table** with its light values has been designed for use with the most often met with lighting conditions and serves to prevent serious errors. In difficult cases or for greatest accuracy, it is advisable to make use of a photo-electric exposure meter. If

the meter is not calibrated for light values, shutter speed and diaphragm scales are set separately. Thus the correct light value will be indirectly ascertained and changes to other combinations may be easily and quickly made in the previously described manner.

General Exposure Rule: It is not always possible to pair a sufficiently fast shutter speed (to minimize effect of subject motion) with a small diaphragm opening (for greater depth of field). Obviously a compromise is required and it would be well to remember that under exposure results in hopelessly lost shadow detail, whereas over exposure may be compensated for a great extent by proper processing. Therefore, a good general rule for exposure is:

Always expose for the **shadows**, rather a bit **more** than too little!

Self-Timer

If the photographer himself wants to appear in the picture, the self-timer is employed instead of the shutter release button. It is cocked automatically by crank action (and is always ready to use). With the exception of B all shutter speeds from 1 to 1/500 sec. may be used. The action of the self-timer allows the photographer approximately 10 seconds before the shutter opens for the previously selected exposure time.

If the shutter has just been released by hand it is perhaps needless to say that the crank must be wound before either a self-timed or any other kind of picture can be taken.

To Release the Self-Timer: push the self-timer release button in the direction of the arrow.

The shutter and self-timer may be left cocked even when the camera is laid away for short periods of time without weakening the power of the springs.

Exposure and Light Value

Correct **exposure** is dependent upon existing illumination (more exactly: subject brightness). The **light value** indicates the correct exposure. A reading is taken from the exposure table or a photo-electric exposure meter set for the proper film speed and then transposed to the light value scale of the camera. The shutter speed and diaphragm opening relationship are thus adjusted at once for the correct exposure.

This correct relationship between the shutter speed and diaphragm opening is automatically maintained by the coupling mechanism even when another speed-diaphragm combination is sought to obtain a certain depth of field (see table). In this case use the shutter **speed** control wheel only. Thus it is possible to quickly choose the most suitable of the possible combinations, without calculations and without changing the basic required exposure.

The light values 13 to 9 permit a choice from six shutter speed and diaphragm opening combinations, ranging from f:4 to f:22, for example, light value 13:

Shutter Speeds	1/500	1/250	1/125	1/60	1/30	1/15
Diaphragm Opening	4	5.6	8	11	16	22

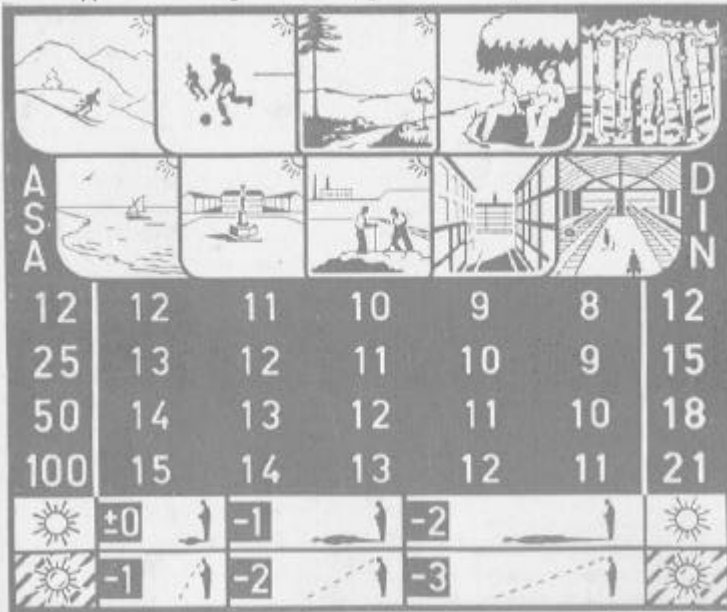

Explanations of the Picture Examples:

A
High mountains (snow) without foreground. Open beach.

B
Sports scenes. Bright streets and squares, open landscapes

C
Landscapes with foreground. Groups in open air.

D
Groups in shade. Street scenes with shade.

E
Groups under trees, slightly shaded. Groups in glass roofed halls.

The Exposure Table

Subject brightness is easily judged and classified by means of the five standard lighting conditions represented by two illustrations each at the top of the table.

Film speed is indicated at the left by ASA figures and at the right by $1/10^\circ$ DIN values.

Light value is found where brightness and film speed columns cross.

Light value adjustment, due to overcast sky or when sun is lower in the sky, is made by use of lower scale. Upper scale: full sunshine — lower scale: overcast sky. The length and intensity of your own body's shadow will give some idea of light conditions. The ability to estimate and choose the correct light values for various lighting conditions and time of day will soon come when you begin working on sunny and cloudy days.

Example: Color film 25 ASA ($15/10^\circ$ DIN), landscape with foreground, sunny, noontime (shadows short, no light value adjustment): light value 11. Available speed-diaphragm combinations: $1/125$ — $f:4$, $1/60$ — $f:5.6$, etc. Same subject in the afternoon, longer shadows, would require adjusted value, perhaps $11 - 1 = 10$.

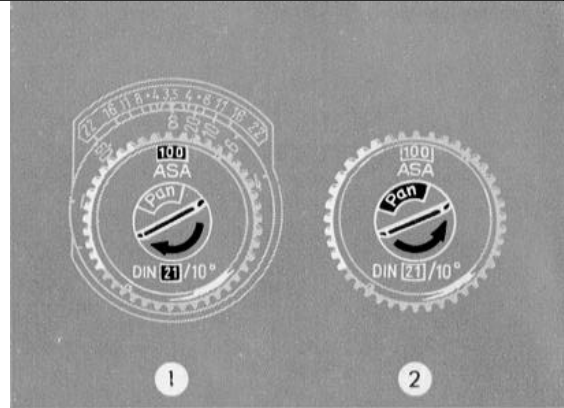

Film Reminder in Focusing Knob

In order to know with which film material the camera was last loaded two adjustable discs, located in the front part of the focusing knob, are rotated by means of a cam in the center: if turned to the **right** (1) it indicates the **speeds** 8 to 160 ASA ($10/10^\circ$ to $23/10^\circ$ DIN) if turned to the **left** (2) it indicates the **film types** Ortho, Pan, Color daylight film and Color artificial light film.

29

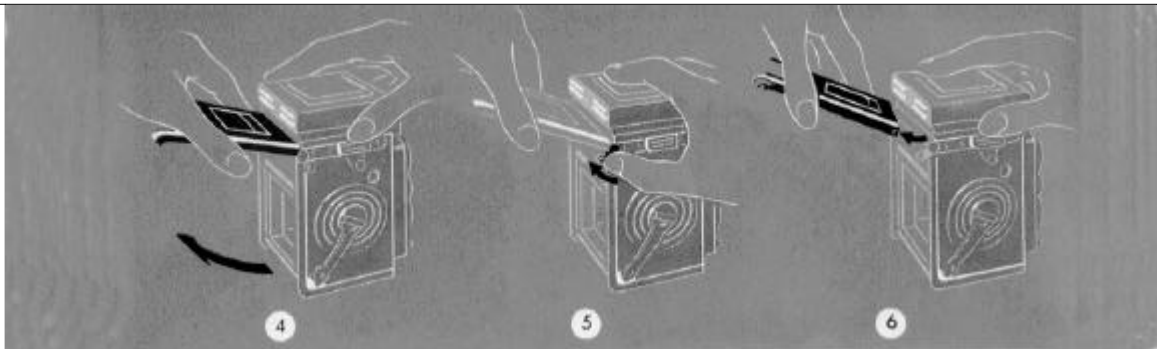

The back of the camera is generally removed only when placed by the plate adapter.

To Remove: open back fully (4) and swing the locking lever on the right side back hinge (crank side) in the same direction until it stops (5). Slip back out of the opened hinge (6).

To Attach: insert detached back first into the left and then into the right hinge (with locking lever in the upper position).

Protect the open camera against prevailing dust and dirt and clean it occasionally with a soft camel's hair brush!

Never change film in direct sunlight, utilize at least your own body's shadow!

The camera may be attached to a **tripod** by means of the threaded socket on the bottom. Caution: the length of the tripod screw must not exceed $3/16$ ". If longer, employ a washer or spacer to avoid damage to camera. For cameras with continental tripod sockets a reducing bushing is available.

31

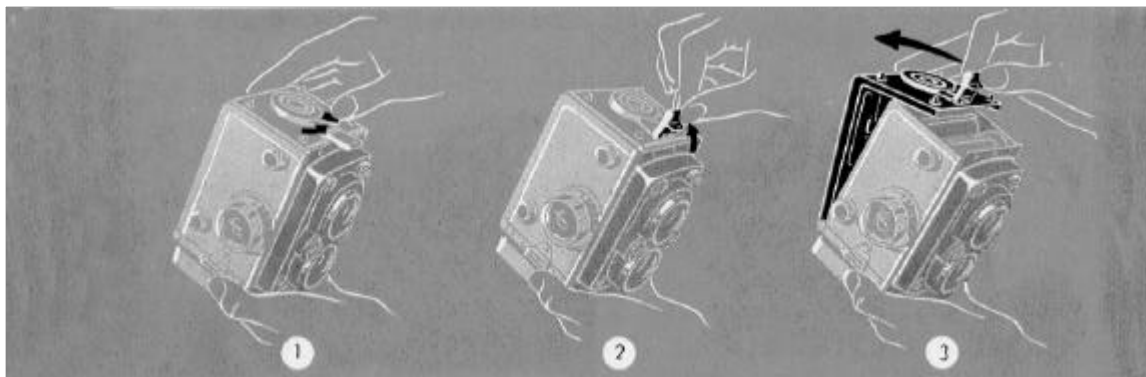

III. LOADING AND FILM TRANSPORT

The Rolleiflex is loaded with $2\frac{1}{4} \times 3\frac{1}{2}$ roll-film 120 and delivers 12 exposures $2\frac{1}{4} \times 2\frac{1}{4}$.

The loading of the camera is confined to a few simple operations: open the back — insert the full film spool — thread the film — close the back. From now on the film transport follows automatically through crank action.

Back

To Open: swing aside the back locking lever at the bottom of the camera (1), lift the clip (2), open back (3), using the clip as a handle.

To Close: with the flat of the hand push the back closed. fold down the clip and return locking lever to full forward position.

30

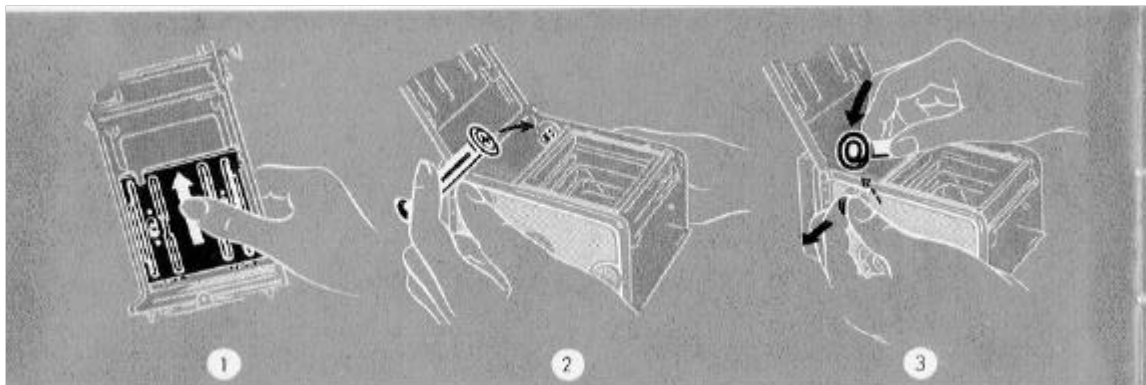

Film Pressure Plate Must be Positioned Correctly!

When 120 roll film is employed, the inscription $2\frac{1}{4} \times 2\frac{1}{4}$ " must be visible below the film pressure plate. When changing from 120 roll film to 35mm film, or the reverse, an adjustment must be made according to the film type being used.

To adjust the film pressure plate (1): Press the plate against the back and push it up or down until it stops. When released it must spring forward completely into the normal plane!

Inserting the Film Spool

In the factory-new camera the empty spool (take-up spool) is already in position. After removal of the exposed film the just emptied spool becomes a take-up spool, and must be transferred to the upper spool-chamber. The end with the slot goes to the right engaging the winding key of the film transport mechanism (2). Both spools are held on the left hand side by spool knobs. The bearing pins are withdrawn when changing spools by pulling out the knobs.

32

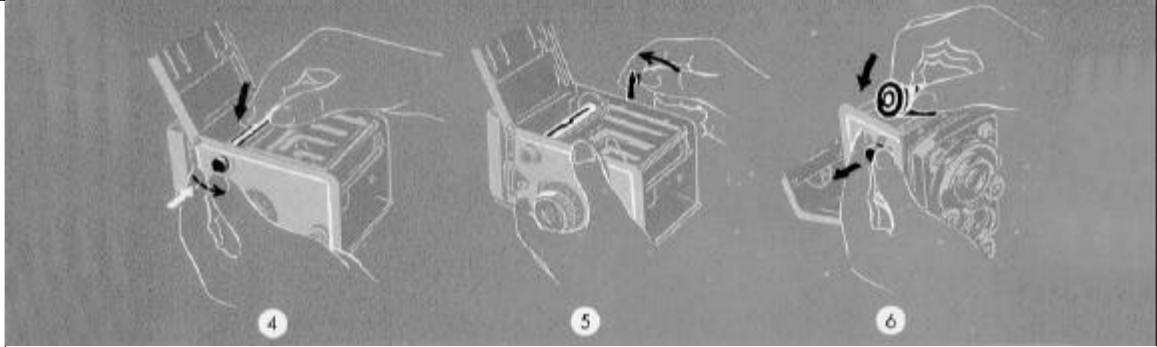

The pulled out upper knob (take-up-spool) may be held in that position by turning it slightly; turning it a little more permits it to snap back by itself.

To Insert the Empty Spool: first fit the spool over the winding key on the right (crank side) and pull out the guide knob (3). Push spool down on the left applying slight pressure, so that the knob may snap back into place fully (4). It is then necessary to turn the crank until the long slot in the empty spool comes uppermost (5).

Note: when using the plate adapter the empty 120 spool is removed from the camera. However, it must be handily retained especially on trips, since otherwise a new roll- film cannot be loaded into the camera.

To Insert a Full Film Spool: in the same way as applies to the take-up spool (6). The pointed end of the backing paper must point in the direction of the take-up spool chamber, so that the colored side of the backing paper remains on the outside.



Swing Out crank (4), turn it until it stops with one continuous swing (5) and then back again until the next stop (6)!

It is now locked, until the automatically cocked shutter is released. The simple rule then reads:

If the crank can be turned, it must be turned — once in each direction until it stops, until it locks!

When advancing the film to exposure No.1 some 4 to 5 complete crank turns are required. During the last turn a slight resistance of the mechanism must be overcome as the counter moves from 0 to 1.

If it should happen that the crank reaches starting position when it stops, reverse direction one full turn, so that it locks!

During continued film transport the amount of crank travel decreases gradually to about a half turn.

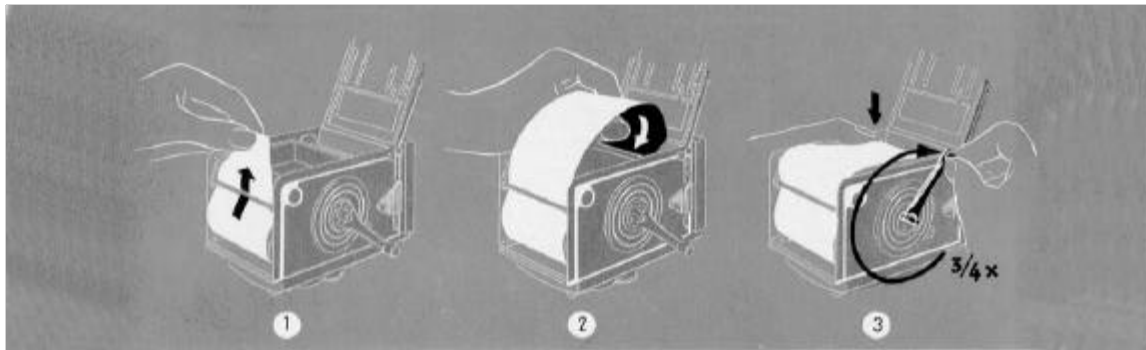

Threading the Film (Paper Leader)

After inserting a full film-spool tear the seal open and remove it.

1. Thread the beginning of the backing paper **through the rollers** of the film feeler mechanism (important!) and draw it up to the take-up spool, colored and printed side outwards (1).
2. Push the paper leader through the long slot of the take-up spool as far as it goes (2).

3. Tighten the backing paper by one spool turn (=approximately 3/4 crank turn), making sure that the paper is wound up properly on the take-up spool (3). Close back (with the film pressure plate adjusted according to instructions!).

Film Transport

The correct positioning of the film according to the first and following numbers of the exposure counter is accomplished exclusively by the crank. The correct operation of this is governed by stops:

34

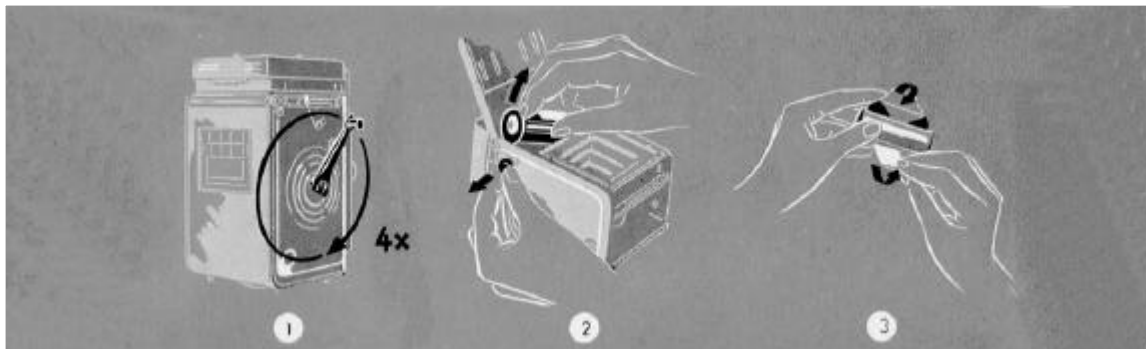

When making exposures in rapid succession it is unnecessary to fold down the crank each time. It remains locked in its starting position, ready for the next film advance, with a slight pressure of the thumb keeping it against its stop.

If longer intervals occur between exposures the question could arise: has the film already been advanced and the shutter cocked? The crank gives the answer immediately.

Only if locked is it "ready to shoot:"!

To Remove the Film

After the 12th and last exposure four complete crank turns are enough to wind off the rest of the backing paper (1).

To Remove: open the back in the shade, pull out upper spool knob and remove the film from the same side (2). Fold under a good portion of the backing paper (for easier opening when developing) and seal (3). Put the exposed film back into the light-proof protective cover of the original package!

36

IV. FLASHLIGHT TECHNIQUE

In modern flashlight technique the camera shutter takes over the task of firing the bulb electrically at the right moment. In this way instantaneous flash exposures are possible with a hand-held camera.

The Synchro-Compur shutter in the Rolleiflex is, for this purpose, equipped with electrical contacts. The contact may be adjusted to the required delay of the flash lamps by means of the Synchro-lever:

The **X-contact** presents the simplest type of contact (zero-delay). It is required for zero-delay electronic flash units (without delay) and a few flash lamps.

The **M-contact** means full synchronization. It works with most flash lamps and the electrically fired flash powder (capsule flash). The most important advantage of the M-contact: with certain flash lamps it may be employed at the shorter shutter speeds even including 1/500th second. Due to the full synchronization the shutter is always open when the flash emitted by the lamp reaches its peak intensity.

Thus all types of instantaneous flash exposures are possible with the Rolleiflex.

The selection of flash lamp-type depends on the light output required by the subject. Many makes are available in three groups (normal, medium and high light output). The selection is dependent on the taking conditions, especially as to whether a room of shallow or great depth is to be illuminated.

Selection of the M-X lever position, applicable speed range and exposures can be learned from the instructions of the different flash light products. Since the development of flash light sources still is in the experimental stage, numerous makes of varying efficiency are available commercially. For the best known makes the table on page 38 contains the necessary information and the permissible shutter speeds.
Connecting Flash Unit: push flash cord plug into the socket on the camera.

To Remove the Flash Cord: Swing the Synchro M-X lever partially to one side and pull out the plug.

When setting contacts X or M:
Swing Synchro-lever a full 180° until it stops!

37

Explanation of the Table

The **Contact column** indicates the correct setting of the M-X lever for each lamp type.

The **"Shutter Speed" column** shows the permissible speed range:

Center: the recommended shutter speed includes practically the entire light output of the flash lamp. This assures the maximum illumination as well as the smallest diaphragm (for greater depth of field). The following applies as a general rule.

Use the standard recommended speed together with the correct setting of the M-X lever for the lamp in use.

Left: the fastest speed indicates the limit to which the shutter may be set. For lively action or sports subjects, the faster speeds are employed.

Right: the exposure time may be increased to the slowest speed (1 second or even time exposures), if, in addition to the flash, it is desired to make use of existing light. In such cases the total amount of light from all sources must be considered in choosing the diaphragm opening.

The **Effective Exposure Time** (as indicated in the table by means of **colored ink**) is not in each case identical to the shutter speed, but depends on the portion of the flash lamp light output utilized:

With X-Contact the duration of the flash itself is actually shorter than any of the permissible shutter speeds. Therefore, the duration of the flash figure shown in parenthesis is the effective appropriate exposure time and the diaphragm opening must be the same regardless of the shutter speed selected.

With M-Contact the shutter speeds, from "fastest" to "recommended" fall within the duration of the flash: they, therefore, represent the actual exposure time and if the shutter speed is increased, the diaphragm must be opened accordingly. Only when slower shutter speeds are employed is the fully utilized light output equal to the actual exposure time, and this is the same as the recommended speed.
The illustration should make the utilization of the available flash light still more obvious, the white symbols represent the flash, and their size, the utilized light at the shutter speed employed.

39

Flash Contact and Permissible Shutter Speeds

FLASH LIGHT SOURCE		Type	Contact	Shutter Speed:	
Make	Without Relay			Fastest	Slowest Recommended
I. Electronic Flash					
General Electric Westinghouse	SM	(1/2000)	X	1/500	1/250
Sylvania	SF	(1/200)	X	1/60	1/60
West, Japan	SS	(1/200)			
Ostram	F0 F1, F2 XP, X0	(1/100) (1/50) (1/200)	X	1/30	1/30
West, Japan	12	(1/100)			
Ostram	S2		M	1/500	1/30
	S0, S1				
Philips (Mazda)	PF 3 N, PF 14, PF 25, PF 56				
General Electric Westinghouse	5, 11, 22		M	1/500	1/60
West, Japan	0, 3, 5, 11, 22				
Sylvania	Press 25, 40, 0, Bantam 8		M	1/250	1/60
	2				
Philips (Mazda)	PF 110				
General Electric Westinghouse	50		M	1/60	1/30
Sylvania	3				
General Electric Westinghouse	6, 31		M	1/250	1/30
West, Japan					
Sylvania	FP 26, 2A				
III. Capsule Flash					
	Average		M	1/125	1/30

How the Flash Contacts Work

The information given thus far is entirely sufficient for normal purposes and is adequately supplemented by the exposure tables usually furnished by the various flash lamp manufacturers.

The photographer who is familiar with and habitually makes use of flash lamp graphs should know something about the method of operation of both flash contacts.

X-Contact (zero-delay): contact is made shortly before the shutter blades reach full opening.

Application: for lamps with short firing time (up to 5 milliseconds) and short flash duration.

M-Contact (full synchronization): contact is made approximately 16.5 milliseconds before the shutter blades are fully opened. Application: for flash lamps with long firing time (average firing delay 16.5 milliseconds) and long light duration.

For safety reasons one pole of the contact is grounded to the camera body (isolation-test 700 volts). All commercially available flash guns and electronic flash units may be used. Current-carrying capacity of the contact when several flash lamps are connected simultaneously: 10 amperes at 24 volts for a period up to a maximum of 1/15th sec.

Tips on Flashlight Photography

1. Use fresh batteries. Condenser or capacitor flash-guns are more consistent since lamp ignition is somewhat less dependent on battery power (Rolleiflash).
2. Be sure that the contacts of the battery and lamp sockets are clean. Handle flash cable with care, avoid kinking, otherwise there will be danger of short-circuit and premature flash ignition. — Note: the contact must not be connected to house current!
3. To light up long rooms or to achieve special illumination effects, one or two Rolleiflash combination extension units may be connected to the Rolleiflash. Connecting cords adding up to a total length of 33 feet (66 feet with fresh battery) may be used. Always insert flash lamps in Rolleiflash first, then in extension units, to avoid premature firing. Unnecessary battery drain will be avoided by inserting lamps just before firing and ejecting immediately afterwards.
4. Blue flash lamps, like electronic flash, simulate daylight and are intended for use with daylight color film.
5. The power of flash illumination decreases according to the square of the distance i.e., an object six feet away receives only one-fourth the light as an object at three feet.

Distance from flash to subject must therefore be carefully considered in selecting diaphragm opening. Lamp manufacturers supply easy to use guide numbers which are divided by the distance in feet to obtain the required diaphragm opening.

6. Flash as main light source: do not take weak room illumination into account, expose strictly according to flash output.

7. Flash as fill-in light: useful in brightening shadows whether due to insufficient illumination or to the fact that the picture is being taken "against-the-light", in full sunlight. The fill-in light must be kept at a lower intensity level than the main source of illumination, otherwise the strong flash will give an unnatural effect, not at all like daylight. Too strong a flash might even cause an apparent underexposure of the sky or the area not reached by the light. Electronic flash units are particularly well suited for use as fill-in lights when shooting color sports pictures. Use smaller lamps or keep them at greater distance.

8. Fully synchronized flash pictures are possible when using the self-timer through the entire shutter speed range from 1-500th sec. with M or X contact settings.

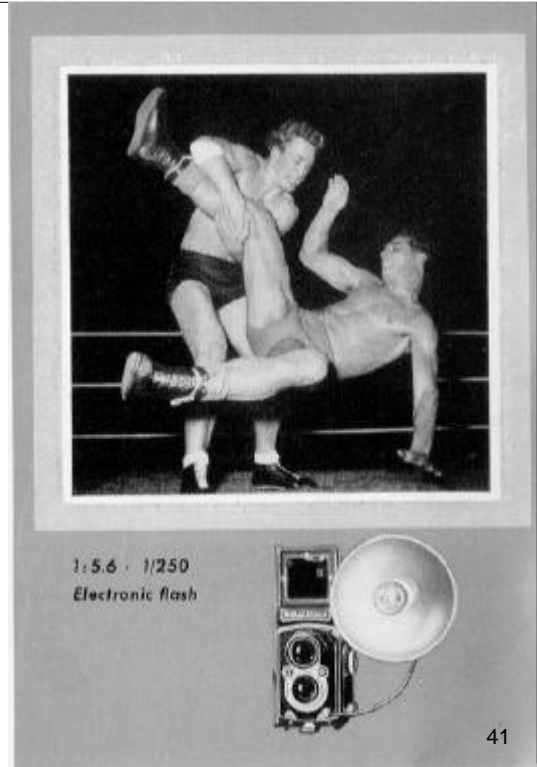

41

2. Haze and Mist: the blue filter, useful for pictorial effects, increases hazy effect. The orange or red cut through and improve the clarity of distant views. The blue filter reduces contrast, the red or orange increases brilliance. Maximum penetration of light haze is obtained with infra-red film and infra-red filter (700 m μ). Barely visible mountain chains are reproduced clearly. An odd effect with this combination is that green leaves are rendered almost white. Filters are of no use at all in really bad weather when there is a considerable amount of moisture in the air.

3. Sea, Beach, Mountains: strong ultra-violet rays must be absorbed through use of U.V. filter. Results will otherwise be dull. The H1 filter serves the same purpose for daylight-color film. Reduction of the bluish cast is quite marked.

Picture Composition Rules: distant views are generally better if foreground contains (for added depth impression) trees, people, animals, etc. Foliage is often used as a frame for the distant view. Focus should be sufficiently sharp in the foreground. Strong effects are created when deep shadows in the foreground are set against the lighter distance. Side lighting or even back lighting gives the most impressive pictures.

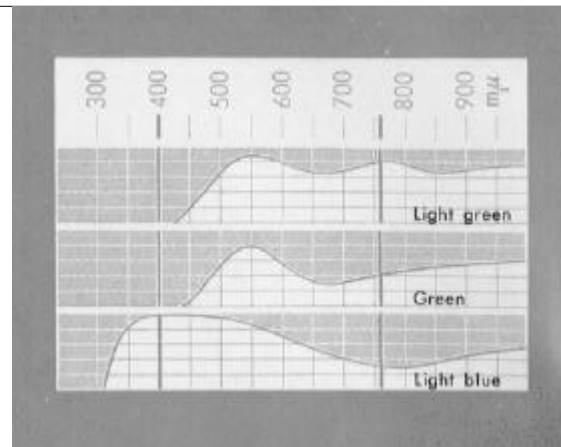

The filter curves show the absorption of the various Rollei filters in the spectral ranges ultra-violet, visible spectrum blue to red (approximately 400—760 m μ), and infra-red. The means: darker portion of the spectrogram = absorbed light; lighter portion = useful light. The light-transmission of the filter from the lowest point to the peak point of the curve thus increase from 0 to 100%. While the H1 filter cuts out the short wave ultra-violet portion of the spectrum, the green filter, absorbs a substantial portion of the long wave red and infra-red range.

43

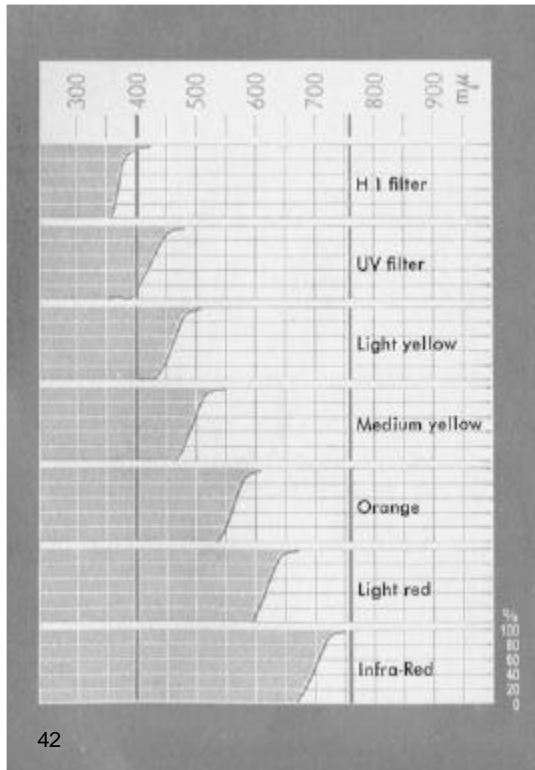

42

V. TIPS ON PICTURE-TAKING

Landscapes

Focusing for distant views with foreground may be accomplished simply without using ground glass except for viewing: set infinity mark (∞) opposite diaphragm opening used — second corresponding diaphragm mark will indicate nearest point in focus. Example: ∞ at f:11 — sharp area ∞ to 17 ft (5 meters).

Filters: important for separating tones, which would otherwise be similarly rendered by the black and white film, or for influencing the mood of the picture.

1. Blue sky with clouds: yellow filters darken blue skies and thus improve the reproduction of clouds. The deeper the color of the filter, the stronger and more dramatic the effect. Blue snow shadows are also rendered truer to tone. The green filter tones down the sky, brightens foliage and darkens the occasionally too lightly rendered reds (with pan film) such as suntanned flesh and red tile roofs.

For filtering the sky but not the landscape: the Rolleipol filter darkens the blue sky only by eliminating the polarized light.



44

Portraits

Large heads: do not work closer than 40 inches to avoid possible perspective distortion. If necessary, enlarge from a smaller section or use Rolleikin. Focus on the eyes. Use quiet, neutral colored backgrounds and do not stop down too much (f:5.6) so as to keep backgrounds from intruding. If possible, move subject away from background. Out of doors, try using sky only as background. Open air portraits are best taken early or late in day when light is softer and not too blinding. Favor soft light, avoid deep shadows. In emergencies use reflectors for fill-in flash. Simple, proven artificial light procedure: lamp No. 1 next to camera somewhat above head level, lamp No. 2 on the side to lighten shadow, approximately 1/30th second. For special effects, lamp No. 3 as overhead or back-light. Important: use lens hood and focusing extension hood for reducing extraneous light. Pan film, no filter. Moisten lips (high-lights!). To reduce sharpness and add "glamour": Rolleisoft (soft diffusion disk) 0 or 1 (stronger) over lens. Use larger diaphragm openings and backlight for sunny effects. (See picture page 45.)

Children

Never use force, watch for interesting effects and expressions carefully. A clever assistant to divert children's attention from camera is often a valuable aid. Try close-up shots of children's expressions as they listen to favorite or exciting stories. Laughter, astonishment, pity and even an occasional yawn provide wonderful material for good shots or picture series. For close-up shots use same technique as for portraits. For children in motion, use snapshots technique outdoors and flash indoors. Low viewpoints and close-up effects are best.

Animals

Patience, quietness and familiarity with the animal and its peculiarities are great assets. Close-up pictures are most rewarding; use portrait technique. Make use of natural light effects such as backlighting. Action pictures: use snapshot or sport technique (with flash, if needed). Rollieinars are often helpful with small animals. Zoo: animal portraits — avoid bars or netting. Hint: netting often becomes invisible when lens nearly touches wire. Fish in aquarium: use side and overhead lighting in otherwise darkened room. A good trick is to limit movement of fish within sharp zone by means of vertical glass plate in tank.



1:4 · 1/125 · Rollei soft 1
filter light green



45

Sports

Sports pictures are generally most effective when the original rapid motion has been sufficiently "arrested" and the subject remains well defined. The fastest shutter speeds are essential, together with careful focusing. Sometimes pre-focusing on the spot where the action is to take place is possible. Do not overlook the possibilities of training sessions, since greater cooperation can often be had at such times. Snapshot technique is valuable for turf and ice shots and for any case when it would be difficult to guess exactly where to focus. Watch your shutter speeds and viewing angle. Shooting at right angle to the direction of the action requires a much faster speed than when the action is going in the other directions (see table page 23). If the action is very fast or takes place close to the camera, it is best to pan or follow with the camera. This results in a sharply rendered main object against a blurred background, thus increasing the impression of speed. There is often a fine moment for shooting when the action reaches a peak and stops momentarily, such as when a pole-vaulter "hits the top" before starting to come down again. With insufficient light or indoors use synchro-flash and 1/500th second. The extremely short duration of electronic flash is highly desirable in some instances. Use the direct view finder; do not overlook the advantages of the Rolleikin with its telephoto effect, maximum use of film oval and greater film capacity.



1:5.6 · 1/500

47



f: 5,6 · 1/500 · filter yellow

Snapshots

Unexpected picture opportunities or rapidly changing subject distance make a simplified technique, based on depth of field zones, highly desirable. The following three settings have been found very effective:

1/125 sec.

Diaphragm opening f:8

Short distances
approximately
9 to 18 ft.

Medium distances
approximately
13 to 33 ft.

Long distances
approximately
18 to 100 ft.

12 ft

20 ft

30 ft

Shutter speeds and diaphragm openings do not often need changing in sunlight. Those suggested cover most contingencies. Thus instead of wasting time focusing when in a hurry, use one of the above settings. This snapshot technique is especially useful with the direct view finder. Variation of the values (see table page 21) makes this technique available for other depth of field zones. Example: diaphragm opening f:11, focus at 30 ft, depth of field extends from 15 ft to ∞ for snapshots of scenes. Chief uses for this technique: groups in motion, sport scenes, playing children, reportage, sports.



Theater and Music Hall

At longer distances only a section of the film is generally used hence this is a good field for using the Rolleikin. Do not depend on footlights but concentrate on spotlighted performers or features. Exposures of 1/30th second are generally adequate under the strong lights with fast pan film. To take flash pictures without knowledge of or disturbing subjects: use dark flash (colored lamps or reflector with infra-red filter) and infra-red films. After pre-setting focus you can use direct view finder most comfortably.

Night

Include direct light sources as symbols of the night in the picture. Only very strong, close lamps must be hidden behind natural foreground objects (building, tree, persons), otherwise over-exposure will result. Make use of effects: reflections in wet streets, light deflected by snow, early twilight with traces of brightness in the sky. Use fast pan film only. For time exposure: cover up lens when auto headlights cross the picture area, to avoid streaks. Use flash for snapshots at night, not for night shots.

Copying

Smaller originals are best copied with Rolleinars. See table page 55 for reproduction sizes. The camera should be set on a rigid, vibration free stand with the original parallel to the film plane. Use a small stop; f:11 recommended. Light evenly from both sides but avoid reflections. Glossy surfaces give less trouble if Rolleipol is used. Colored originals may require filter for better tone separation. Use contrasty ortho film (or even positive film with Rolleikin) for black and white originals. Spots on originals can be minimized by using a filter similar in color to spot with pan film. The Rolleikin is especially valuable for series or archive work. Single reproductions are economically taken with the plate back adapter. Reproductions from books are readable with ordinary magnifier directly from $2\frac{1}{4} \times 2\frac{1}{4}$ contact prints. Small objects (small machine parts, assembly pieces) may be handled similarly to copying. A spotlight can often be an additional aid in this case. Shadowless lighting effect are facilitated by placing object on suspended glass plate. Reflections from fine glassware or other highly reflecting objects can be reduced to a minimum, if the object is photographed by reflected light such as can be had inside an illuminated, white painted box.



1:11 · 30 sec · Rolleinar 1



49

Plants

Flowers, blooms and grass are most effective in close-ups taken against the light. Use Rolleinars with fill-in light or reflectors. Stop down for needed depth of field and shoot in bright light with no wind. A semi-circular shaped cellophane shield is an effective guard against the ground breezes that destroy definition. Use filters to differentiate between equally bright colors. Keep in mind that a filter renders its own or similar colors lighter, whereas its complimentary color comes out darker.

Color Photography

Color films have little exposure latitude, so avoid strong light contrasts and use exposure meter. In doubtful cases make three exposures, varying diaphragm opening one half stop each side of what is considered normal. Correct color reproduction is possible only with correct matching of proper film types with illumination. Use compensating filters when needed according to manufacturer's instructions. Rolleipol-Filter: reduces glare from reflecting surfaces, also darkens the blue color of the sky (page 42) without affecting the color of the landscape. Select subjects with pleasing large color patches, not just an accumulation of loud colors. Overcast sky often renders pleasing pastel effect.



1:16 · 1/30 · Rolleinar 2
filter yellow



51

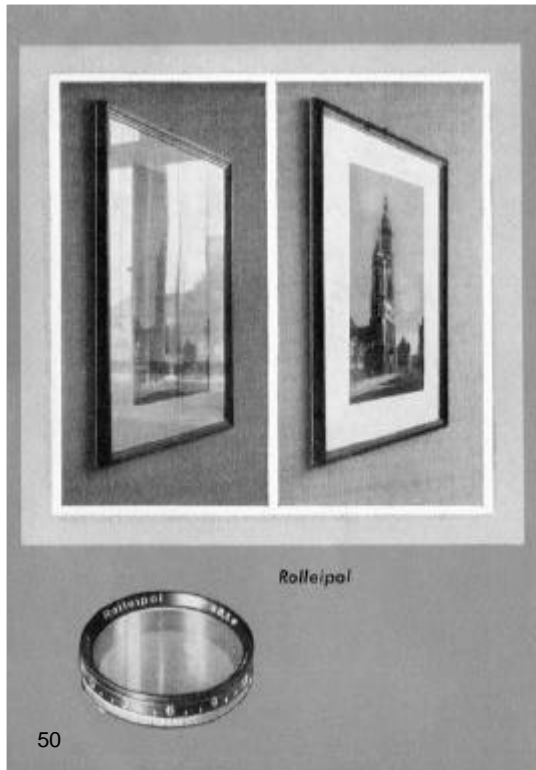

Shiny Surfaces

Eye-glasses, pictures, water surfaces, window glass and other brilliant reflecting surfaces often give disturbing reflections, not always avoidable by changing angle or illumination. A simple remedy in many cases is to use the polarizing filter Rolleipol. Reflected light is often polarized in one direction and this can be absorbed or reduced by proper orientation of the Rolleipol. This is done by merely turning it for best effect. It may sometimes be necessary to change camera position to obtain best angle. In artificial light a second pola-filter over the light gives full control at any angle. When the reflections are removed objects seen through the shiny glass or water surfaces become clearly evident. Torsion or strain test of various materials are also possible with the help of the Rolleipol. Reflections from certain metal surfaces when the Rolleipol has little or no effect are best handled by photographing in diffused light or changing direction of illumination. Small, shiny metal parts can be held over burning magnesium to provide a white coat or greased and rubbed with graphite.

Pictures Through the Microscope

When a microscope is focused by someone with normal eye-sight, the eye sees the image as if it were at infinity. Consequently, the Rolleiflex, also focused at infinity, can simply take the place of the eye over the microscope in order to record the image on film. Microscope and camera should be mounted on firm stands, without mechanical connections. Place the camera so that taking lens, focused at ∞ , is brought as close as possible to the ocular. Check optical axis carefully; film plane should be parallel to surface being photographed. For full coverage of $2\frac{1}{4} \times 2\frac{1}{4}$ use wide angle ocular, however, sufficient coverage for Rolleiflex negative is to be had in any case. Framing through view finder is unnecessary. Do not stop down since this has no effect on exposure. Factors affecting exposure are illumination and transmission of the objective, to be ascertained through tests. Apochromatic micro-lenses are best, particularly with color film. In shooting black and white with these lenses, use ortho material and green filter. Generally interesting are micro-pictures of crystallized chemicals through Rolleipol filter in conjunction with another pola-filter over microscope condenser.

Care of the Rolleiflex

A precision camera demands care in handling. Protect it against moisture, dust, sand, strong sunshine, hard blows or falls. First safeguard: the ever ready case. Second safeguard (when not in use while traveling): a rubber bag to guard against water, sand or snow. Carry camera around neck to minimize transportation chocks. Keep all parts clear and clean lenses with a soft camel's hair brush or doeskin. Although the mechanism is not unduly sensitive to cold, some condensation may form on the lenses when the camera is brought into a warm room from outside in cold weather. Do not wipe off — let moisture evaporate. In the tropics arrange to keep the camera, when not in use, in an air-tight container.

In Case of Damage to the Rolleiflex

The task of repairing major or minor damage is the special province of the expertly trained mechanic. Franke & Heidecke maintain their own special workshop in which all repairs are done with precision at nominal prices. Abroad, apply to photo dealers and factory representatives for full information.

The Practical Accessories for the Rolleiflex Automat

Code:	Ever Ready Case for Rolleiflex Automat	Code:	Leather Case containing: 1 Lens Hood and your choice of 2 Filters
Berau	Lens Hood	Etset	Leather Case only
Baobe	Rollei Yellow Filter, light	Etsof	Complete Plate Adapter Equipment comprising: 1 Plate Adapter, 3 Slides
Baihe	Rollei Yellow Filter, medium	Focum	1 Focusing Screen Slide, 1 Leather Case for 2 Slides
Balin	Rollei Green Filter, light	Foapt	Plate Adapter
Baeen	Rollei Green Filter	Fosli	Slide
Basky	Rollei UV Filter	Fopla	Cut-Film Sheath
Baora	Rollei Orange Filter	Focas	Leather Case for 2 Slides
Baubi	Rollei Red Filter, light	Fofoc	Focusing Screen Slide
Babla	Rollei Blue Filter, light	Rolki	Rolleikin 2
Bahaz	Rollei H 1 Filter (UV Filter for Daylight Color Photography)	Foead	Panorama Head
Bafir	Rollei Infra-Red Filter	Fohod	Extension Hood
Batnu	Rolleisoft 0	Fogri	Rolleigril Lens
Baton	Rolleisoft 1	Basyn	Rolleiflash Attachment
Batar	Rolleipol	Boxin	Boxin Case for 1 Rolleiflash + 1 Rolleiflash-Comb.
Bapun	Rolleinar Lenses, set 1 (40-18 in.)	Cekab	Extension Cord for Flash-Attachment 10 ft.
Baken	Rolleipar Lens 1	Flaco	Extension Flashholder Rolleiflash-Comb. with Connecting Cord 80 in.
Baodo	Rolleinar Lenses, set 2 (20-12 in.)	Trika	Extension Cord for Rolleiflash-Comb. 10 ft.
Bakdu	Rolleipar Lens 2	Blika	Flash connecting Cord 32 in.
Etcom	Leather Case containing: 1 Lens Hood, 2 Sets of Rolleinar Lenses, 2 Rolleipar Lenses and your choice of 5 filters	Mardu	Rolleimarin Pressure Proof Underwater Housing
Etlee	Leather Case Only		

To avoid errors when ordering accessories please specify camera-number.

Full information on the use of Rollei accessories in the booklet "The Practical Accessories"

53

Focal Length and Focusing-Range with Rolleinar Lenses

Rolleinar Lenses	—	1	2
Focal Length	75 mm	71 mm	68 mm
Focusing-Range (in inches)	∞ — 35 $\frac{1}{2}$	39 $\frac{1}{2}$ — 17 $\frac{3}{4}$	19 $\frac{3}{4}$ — 12 $\frac{1}{8}$

Field-Size and Scale of Reproduction

Focused Distance	31 $\frac{1}{2}$ in.	19 $\frac{3}{4}$ in.	31 in.
Field-Size (in inches)	2 $\frac{1}{4}$ x 2 $\frac{1}{4}$	13 $\frac{3}{4}$ x 13 $\frac{3}{4}$	8 $\frac{3}{4}$ x 8 $\frac{3}{4}$
Scale of Reproduction approx.	1 : 10	1 : 6.3	1 : 3.9

Depth of Field with Rolleinar Lenses

Rolleinar Focused Distance (in inches)	1		2		f / Stop
	31 $\frac{1}{2}$	23 $\frac{1}{2}$	19 $\frac{3}{4}$	15 $\frac{3}{4}$	
from 29 $\frac{1}{2}$ to 33 $\frac{1}{2}$	22 $\frac{1}{2}$	24 $\frac{3}{4}$	18 $\frac{1}{8}$	20 $\frac{1}{2}$	5.6
from 28 $\frac{3}{4}$ to 34 $\frac{1}{4}$	22 $\frac{1}{4}$	25 $\frac{1}{4}$	18 $\frac{3}{4}$	20 $\frac{7}{8}$	8
from 28 to 35 $\frac{3}{4}$	21 $\frac{5}{8}$	26	18 $\frac{1}{8}$	21 $\frac{1}{4}$	11
from 26 $\frac{3}{4}$ to 38 $\frac{1}{4}$	20 $\frac{7}{8}$	27 $\frac{1}{4}$	17 $\frac{3}{4}$	22	16
from 25 $\frac{1}{4}$ to 41 $\frac{3}{4}$	20	28 $\frac{3}{4}$	16 $\frac{7}{8}$	23 $\frac{1}{4}$	22

Taking-distance measured from lens panel to object. Permissible circle of confusion in this special case (due to the large image and less need for enlarging) = f/1000. For increased sharpness further stopping down is required.

55

Table of Rollei Filters

The filter factors indicate average values which, however, may be changed according to the particular type and make of film used and the light conditions.

Rollei Filter	Use	Filter Factor	
		Ortho	Pan
Light yellow	Landscapes, snow, clouds, Renders yellow and green lighter, blue darker.	-1.5	-1
Medium yellow		-2	-1.5
Light green	Landscapes, snow, clouds, Renders green lighter, red (complexion) and blue darker. For pan emulsions.	-1.5	-1
Green		-2	-1.5
Orange	Hazy distant views. Renders yellow-red lighter, blue darker, distant objects clearer.	-1.5	to -3
Light red	Hazy distant views. Renders red lighter, blue-green darker. Gives stronger effects than Orange Filter.	-2	to -3.5
Light blue	Artificial light. Renders red darker. For ultra-pan emulsions.	-0.5	-0.5
UV	High altitudes above 6000 feet. Seascapes. Eliminates ultra-violet rays which reduce contrast.	-0.5	-0.5
Infra-Red	Special filter for infra-red emulsions. Transmits dark red above 700 mu and infra-red.	*)	
H 1	UV-Filter, especially designed for long distance color photography. Absorbs ultra-violet rays, subdues predominance of blue and cuts aerial haze in distance shots.	No increase of exposure	

*) Exposure depends on the type of emulsion used and must be determined by tests.

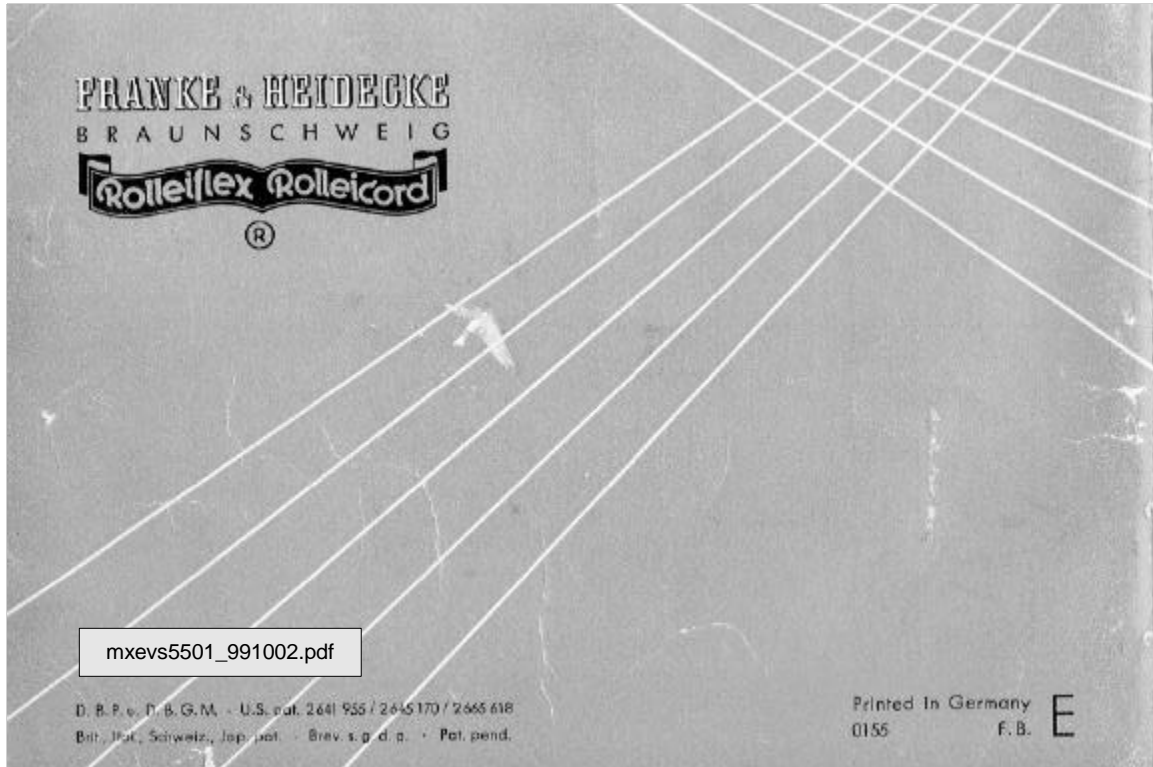

The Practical Accessories for the Rolleiflex Automat

Code:	Ever Ready Case for Rolleiflex Automat	Code:	Leather Case containing: 1 Lens Hood and your choice of 2 Filters
Berau	Lens Hood	Etset	Leather Case only
Baobe	Rollei Yellow Filter, light	Etsf	Complete Plate Adapter Equipment comprising: 1 Plate Adapter, 3 Slides
Baihe	Rollei Yellow Filter, medium	Focm	1 Focusing Screen Slide, 1 Leather Case for 2 Slides
Balin	Rollei Green Filter, light	Foapt	Plate Adapter
Baeen	Rollei Green Filter	Fosli	Slide
Basky	Rollei UV Filter	Fopla	Cut-Film Sheath
Baora	Rollei Orange Filter	Focas	Leather Case for 2 Slides
Baubi	Rollei Red Filter, light	Fofoc	Focusing Screen Slide
Babla	Rollei Blue Filter, light	Rolki	Rolleikin 2
Bahaz	Rollei H 1 Filter (UV Filter for Daylight Color Photography)	Foead	Panorama Head
Bafir	Rollei Infra-Red Filter	Fohod	Extension Hood
Batnu	Rolleisoft 0	Fogri	Rolleigrd Lens
Baton	Rolleisoft 1	Basyn	Rolleiflash Attachment
Batar	Rolleipol	Boxin	Boxin Case for 1 Rolleiflash + 1 Rolleiflash-Comb.
Bapun	Rolleinar Lenses, set 1 (40-18 in.)	Cekab	Extension Cord for Flash-Attachment 10 ft.
Baken	Rolleipar Lens 1	Flaco	Extension Flashholder Rolleiflash-Comb. with Connecting Cord 80 in.
Baodo	Rolleinar Lenses, set 2 (20-12 in.)	Trika	Extension Cord for Rolleiflash-Comb. 10 ft.
Bakdu	Rolleipar Lens 2	Blika	Flash connecting Cord 32 in.
Etcom	Leather Case containing: 1 Lens Hood, 2 Sets of Rolleinar Lenses, 2 Rolleipar Lenses and your choice of 5 filters	Mardu	Rolleimarin Pressure Proof Underwater Housing
Etlee	Leather Case Only		

To avoid errors when ordering accessories please specify camera-number.

Full information on the use of Rollei accessories in the booklet "The Practical Accessories"

53

Focal Length and Focusing-Range with Rolleinar Lenses

Rolleinar Lenses	—	1	2
Focal Length	75 mm	71 mm	68 mm
Focusing-Range (in inches)	∞ — 35 $\frac{1}{2}$	39 $\frac{1}{2}$ — 17 $\frac{3}{4}$	19 $\frac{3}{4}$ — 12 $\frac{1}{8}$

Field-Size and Scale of Reproduction

Focused Distance	31 $\frac{1}{2}$ in.	19 $\frac{3}{4}$ in.	31 in.
Field-Size (in inches)	2 $\frac{1}{4}$ x 2 $\frac{1}{4}$	13 $\frac{3}{4}$ x 13 $\frac{3}{4}$	8 $\frac{3}{4}$ x 8 $\frac{3}{4}$
Scale of Reproduction approx.	1 : 10	1 : 6.3	1 : 3.9

Depth of Field with Rolleinar Lenses

Rolleinar Focused Distance (in inches)	1		2		f / Stop
	31 $\frac{1}{2}$	23 $\frac{1}{2}$	19 $\frac{3}{4}$	15 $\frac{3}{4}$	
from 29 $\frac{1}{2}$ to 33 $\frac{1}{2}$	22 $\frac{1}{2}$	24 $\frac{3}{4}$	18 $\frac{1}{8}$	20 $\frac{1}{2}$	5.6
from 28 $\frac{3}{4}$ to 34 $\frac{1}{4}$	22 $\frac{1}{4}$	25 $\frac{1}{4}$	18 $\frac{3}{4}$	20 $\frac{7}{8}$	8
from 28 to 35 $\frac{3}{4}$	21 $\frac{5}{8}$	26	18 $\frac{1}{8}$	21 $\frac{1}{4}$	11
from 26 $\frac{3}{4}$ to 38 $\frac{1}{4}$	20 $\frac{7}{8}$	27 $\frac{1}{4}$	17 $\frac{3}{4}$	22	16
from 25 $\frac{1}{4}$ to 41 $\frac{3}{4}$	20	28 $\frac{3}{4}$	16 $\frac{7}{8}$	23 $\frac{1}{4}$	22

Taking-distance measured from lens panel to object. Permissible circle of confusion in this special case (due to the large image and less need for enlarging) = f/1000. For increased sharpness further stopping down is required.

55

Table of Rollei Filters

The filter factors indicate average values which, however, may be changed according to the particular type and make of film used and the light conditions.

Rollei Filter	Use	Filter Factor	
		Ortho	Pan
Light yellow	Landscapes, snow, clouds, Renders yellow and green lighter, blue darker.	-1.5	-1
Medium yellow		-2	-1.5
Light green	Landscapes, snow, clouds, Renders green lighter, red (complexion) and blue darker. For pan emulsions.	-1.5	-1
Green		-2	-1.5
Orange	Hazy distant views. Renders yellow-red lighter, blue darker, distant objects clearer.	-1.5	to -3
Light red	Hazy distant views. Renders red lighter, blue-green darker. Gives stronger effects than Orange Filter.	-2	to -3.5
Light blue	Artificial light. Renders red darker. For ultra-pan emulsions.	-0.5	-0.5
UV	High altitudes above 6000 feet. Seascapes. Eliminates ultra-violet rays which reduce contrast.	-0.5	-0.5
Infra-Red	Special filter for infra-red emulsions. Transmits dark red above 700 mu and infra-red.	*)	
H 1	UV-Filter, especially designed for long distance color photography. Absorbs ultra-violet rays, subdues predominance of blue and cuts aerial haze in distance shots.	No increase of exposure	

*) Exposure depends on the type of emulsion used and must be determined by tests.

